



CHARACTERISTICS

- Functioning by deformation.
- European approval for structural applications in non-cracked concrete.
- European approval for non-structural applications in cracked and non-cracked concrete. Also for hollow core slabs (only HE-HC)
- Installation prior to the material to be fixed.
- Version for fastening diamond cutting equipment: HEHOM12D/HECLOM12D.
- Bolt can be disassembled so that the surface of the base material is smooth.
- Bolt non included.
- VdS available for sizes from M8 to M20 (HEHO, HECL, HEA4, HEC4, HEHC)
- FM available for sizes from M10 to M16 (HEHO, HECL)
- Available in INDEXcal.

APPLICATIONS

- Fixing suspended ceilings, sprinklers and ventilation systems.
- Structural fixing, inner and outer ironworks
- Fixing threaded bars
- Fixing in hollow core slabs (only HE-HC)

SIZES

M6 - M20

MAXIMUM LOAD RECOMMENDED IN NON-CRACKED CONCRETE [kg]

HE-HO/CL/NS

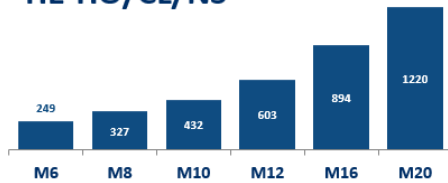

HEA4/C4

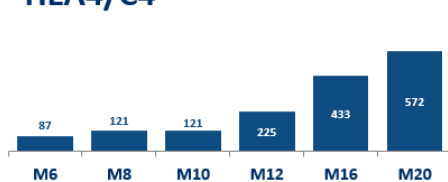

HEHC

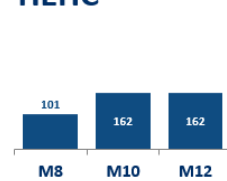

ASSESSMENTS



DRILL CONDITIONS

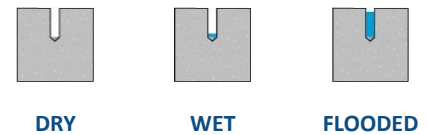







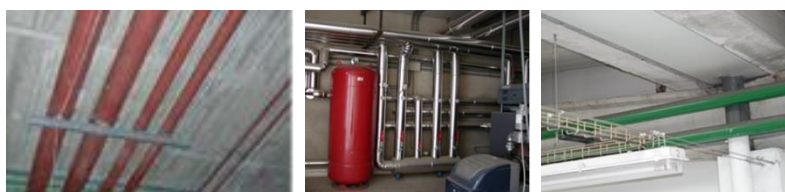











BASE MATERIAL



APPLICATION EXAMPLES



1. RANGE						
ITEM	CODE	SIZE	PHOTO	COMPONENT	MATERIAL	COATING
1	HE-HO	M6 to M20		Capsule Cone	Carbon steel Carbon steel Zinc plated $\geq 5 \mu\text{m}$	
2	HE-CL	M6 to M16		Capsule Cone	Carbon steel Carbon steel Zinc plated $\geq 5 \mu\text{m}$	
3	HE-A4	M6 to M20		Capsule Cone	Stainless steel A4 Stainless steel A4	
4	HE-C4	M6 to M12		Capsule Cone	Stainless steel A4 Stainless steel A4	
5	HE-NO	M6 to M20		Capsule Cone	Carbon steel Carbon steel Zinc plated $\geq 5 \mu\text{m}$	
6	HE-NS	M6 to M20		Capsule Cone	Carbon steel Carbon steel Atlantis $\geq 40 \mu\text{m}$	
7	HE-HC	M8 to M12		Capsule Cone	Carbon steel Carbon steel Zinc plated $\geq 5 \mu\text{m}$	

2. ACCESSORIES				
ITEM	CODE	PHOTO	DESCRIPTION	VALID FOR
1	EXP		Installation tool with rubber handle for M6-M16	HE-HO / HE-CL HEA4 / HE-C4 HE-NO HE-NS
2	EXP		Installation tool for M20	HE-HO HEA4 HE-NO
3	EXP-C		Installation tool with rubber handle for M8-M12	HE-HC
4	HE-HO SDS		Stop drill bit for M6-M12	HE-HO / HE-CL HEA4 / HE-C4 HE-NO HE-NS
5	HE-HC SDS		Stop drill bit for M8-M12	HE-HC

3.INSTALLATION DATA IN CONCRETE

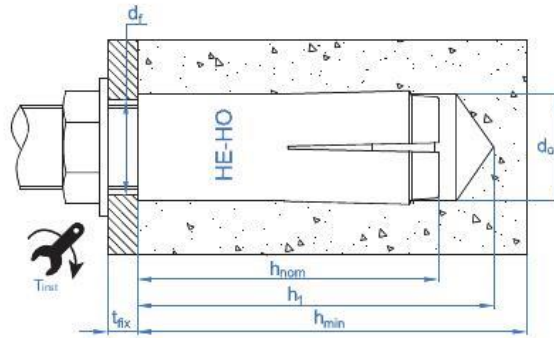

3.1 STRUCTURAL APPLICATION

Family	Code	Size	Assessed	Drill diameter	Fixture diameter	Max. Installation torque	Minimum spacing	Minimum edge distance	Minimum concrete thickness	Hole depth	Installation depth	Bolt length*	Critical spacing	Critical edge distance	Installation tool
[--]	[--]	[--]	ETA	d ₀	d _f	T _{ins}	S _{min}	C _{min}	h _{min}	h ₁	h _{nom}	e	S _{cr,N}	C _{cr,N}	[--]
				[--]	[--]	[--]	[--]	[--]	[--]	[--]	[--]	[--]	[--]	[--]	[--]
HE-HO	HEHOM06	M6 x 25 Ø8	✓	8	7	4	60	105	100	27	25	6 – 10	75	38	EXHBM06
	HEHOM08	M8 x 30 Ø10	✓	10	9	11	60	105	100	33	30	8 – 13	90	45	EXHBM08
	HEHOM10	M10 x 40 Ø12	✓	12	12	17	80	140	100	43	40	10 – 17	120	60	EXHBM10
	HEHOM12	M12 x 50 Ø15	✓	15	14	38	100	175	100	54	50	12 – 21	150	75	EXHBM12
	HEHOM16	M16 x 65 Ø20	✓	20	18	60	130	230	130	70	65	16 – 27	195	98	EXHBM16
	HEHOM20	M20 x 80 Ø25	✓	25	22	100	160	280	160	86	80	20 – 34	240	120	EXHBM20
	HEHOM12D	M12 x 50 Ø16	--	16	12	38	100	175	100	50	50	12 – 21	150	75	EXHBM12
HE-NO	HENOM06	M6 x 25 Ø8	--	8	7	4	60	105	100	27	25	6 – 10	75	38	EXHBM06
	HENOM08	M8 x 30 Ø10	--	10	9	11	60	105	100	33	30	8 – 13	90	45	EXHBM08
	HENOM10	M10 x 40 Ø12	--	12	12	17	80	140	100	43	40	10 – 17	120	60	EXHBM10
	HENOM12	M12 x 50 Ø15	--	15	14	38	100	175	100	54	50	12 – 21	150	75	EXHBM12
	HENOM16	M16 x 65 Ø20	--	20	18	60	130	230	130	70	65	16 – 27	195	98	EXHBM16
	HENOM20	M20 x 80 Ø25	--	25	22	100	160	280	160	86	80	20 – 34	240	120	EXHBM20
HE-CL	HECLOM06	M6 x 25 Ø8	✓	8	7	4	60	105	100	27	25	6 – 10	75	38	EXHBM06
	HECLOM08	M8 x 30 Ø10	✓	10	9	11	60	105	100	33	30	8 – 13	90	45	EXHBM08
	HECLOM10	M10 x 40 Ø12	✓	12	12	17	80	140	100	43	40	10 – 17	120	60	EXHBM10
	HECLOM12	M12 x 50 Ø15	✓	15	14	38	100	175	100	54	50	12 – 21	150	75	EXHBM12
	HECLOM16	M16 x 65 Ø20	✓	20	18	60	130	230	130	70	65	16 – 27	195	98	EXHBM16
	HECLOM12D	M12 x 50 Ø16	--	16	12	38	100	175	100	54	50	12 – 21	150	75	EXHBM12
HE-A4	HEA4M06	M6 x 25 Ø8	--	8	7	4	60	105	100	27	25	6 – 10	75	38	EXHBM06
	HEA4M08	M8 x 30 Ø10	--	10	9	11	60	105	100	33	30	8 – 13	90	45	EXHBM08
	HEA4M10	M10 x 40 Ø12	--	12	12	17	80	140	100	43	40	10 – 17	120	60	EXHBM10
	HEA4M12	M12 x 50 Ø15	--	15	14	38	100	175	100	54	50	12 – 21	150	75	EXHBM12
	HEA4M16	M16 x 65 Ø20	--	20	18	60	130	230	130	70	65	16 – 27	195	98	EXHBM16
	HEA4M20	M20 x 80 Ø25	--	25	22	100	160	280	160	86	80	20 – 34	240	120	EXHBM20
HE-C4	HEA4M06	M6 x 25 Ø8	--	8	7	4	60	105	100	27	25	6 – 10	75	38	EXHBM06
	HEC4M08	M8 x 30 Ø10	--	10	9	11	60	105	100	33	30	8 – 13	90	45	EXHBM08
	HEC4M10	M10 x 40 Ø12	--	12	12	17	80	140	100	43	40	10 – 17	120	60	EXHBM10
	HEC4M12	M12 x 50 Ø15	--	15	14	38	100	175	100	54	50	12 – 21	150	75	EXHBM12
HE-NS	HENSM06	M6 x 25 Ø8	--	8	7	4	60	105	100	27	25	6 – 10	75	38	EXHBM06
	HENSM08	M8 x 30 Ø10	--	10	9	11	60	105	100	33	30	8 – 13	90	45	EXHBM08
	HENSM10	M10 x 40 Ø12	--	12	12	17	80	140	100	43	40	10 – 17	120	60	EXHBM10
	HENSM12	M12 x 50 Ø15	--	15	14	38	100	175	100	54	50	12 – 21	150	75	EXHBM12
	HENSM16	M16 x 65 Ø20	--	20	18	60	130	230	130	70	65	16 – 27	195	98	EXHBM16

(*) Bolt length to be threaded(not included) = e + washer thickness + thickness of material to be fixed

3.2 NON-STRUCTURAL APPLICATION

Family	Code	Size	Assessed	Drill bit diameter	Fixture diameter	Max. Installation torque	Minimum spacing	Minimum edge distance	Minimum concrete thickness	Hole depth	Installation depth	Bolt length*	Critical spacing	Critical edge distance	Installation tool
[--]	[--]	[--]	ETA	d ₀	d _f	T _{ins}	s _{min}	c _{min}	h _{min}	h ₁	h _{nom}	e	s _{cr,N}	c _{cr,N}	[--]
				[--]	[--]	[--]	[--]	[--]	[--]	[--]	[--]	[--]	[--]	[--]	[--]
HE-HO	HEHOM06	M6 x 25 Ø8	✓	8	7	4	60	105	100	27	25	6 – 10	75	38	EXHBM06
	HEHOM08	M8 x 30 Ø10	✓	10	9	11	60	105	100	33	30	8 – 13	90	45	EXHBM08
	HEHOM10	M10 x 40 Ø12	✓	12	12	17	80	140	100	43	40	10 – 17	120	60	EXHBM10
	HEHOM12	M12 x 50 Ø15	✓	15	14	38	100	175	100	54	50	12 – 21	150	75	EXHBM12
	HEHOM16	M16 x 65 Ø20	✓	20	18	60	130	230	130	70	65	16 – 27	195	98	EXHBM16
	HEHOM20	M20 x 80 Ø25	✓	25	22	100	160	280	160	86	80	20 – 34	240	120	EXHBM20
HEHOM12D	M12 x 50 Ø16	✓	16	12	38	100	175	100	50	50	12 – 21	150	75	EXHBM12	
HE-CL	HECLOM06	M6 x 25 Ø8	✓	8	7	4	60	105	100	27	25	6 – 10	75	38	EXHBM06
	HECLOM08	M8 x 30 Ø10	✓	10	9	11	60	105	100	33	30	8 – 13	90	45	EXHBM08
	HECLOM10	M10 x 40 Ø12	✓	12	12	17	80	140	100	43	40	10 – 17	120	60	EXHBM10
	HECLOM12	M12 x 50 Ø15	✓	15	14	38	100	175	100	54	50	12 – 21	150	75	EXHBM12
	HECLOM16	M16 x 65 Ø20	✓	20	18	60	130	230	130	70	65	16 – 27	195	98	EXHBM16
	HECLOM12D	M12 x 50 Ø16	✓	16	12	38	100	175	100	54	50	12 – 21	150	75	EXHBM12
HE-A4	HEA4M06	M6 x 25 Ø8	✓	8	7	4	60	105	100	27	25	6 – 10	200	150	EXHBM06
	HEA4M08	M8 x 30 Ø10	✓	10	9	11	60	105	100	33	30	8 – 13	200	150	EXHBM08
	HEA4M10	M10 x 40 Ø12	✓	12	12	17	80	140	100	43	40	10 – 17	200	150	EXHBM10
	HEA4M12	M12 x 50 Ø15	✓	15	14	38	100	175	100	54	50	12 – 21	200	150	EXHBM12
	HEA4M16	M16 x 65 Ø20	✓	20	18	60	130	230	130	70	65	16 – 27	260	195	EXHBM16
	HEA4M20	M20 x 80 Ø25	✓	25	22	100	160	280	160	86	80	20 – 34	320	240	EXHBM20
HE-C4	HEC4M06	M6 x 25 Ø8	✓	8	7	4	60	105	100	27	25	6 – 10	200	150	EXHBM06
	HEC4M08	M8 x 30 Ø10	✓	10	9	11	60	105	100	33	30	8 – 13	200	150	EXHBM08
	HEC4M10	M10 x 40 Ø12	✓	12	12	17	80	140	100	43	40	10 – 17	200	150	EXHBM10
	HEC4M12	M12 x 50 Ø15	✓	15	14	38	100	175	100	54	50	12 – 21	200	150	EXHBM12
HE-HC	HEHCM08	M8 x 25 Ø10	✓	10	9	11	75	60	80	28	25	8 – 13	120	60	EXHBM08C
	HEHCM10	M10 x 25 Ø12	✓	12	12	17	75	60	80	28	25	10 – 17	120	60	EXHBM10C
	HEHCM12	M12 x 25 Ø15	✓	15	14	38	75	60	80	29	25	12 – 21	120	60	EXHBM12C

(*) Bolt length to be threaded (not included) = e + washer thickness + thickness of material to be fixed

4.INSTALLATION DATA IN HOLLOW CORE

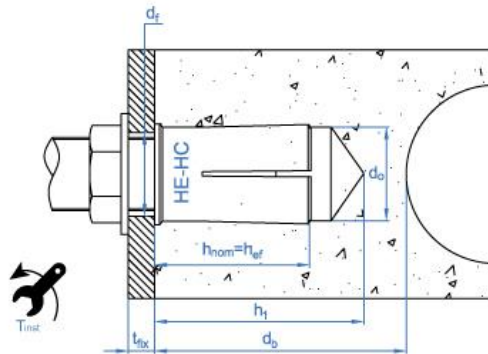



4.1 NON-STRUCTURAL APPLICATION

Family	Code	Size	Assessed	Drill bit diameter	Fixture diameter	Max. Installation torque	Minimum spacing	Minimum edge distance	Minimum bottom flange thickness	Hole depth	Installation depth	Bolt length*	Critical Spacing	Critical edge distance	Installation tool
[--]	[--]	[--]	ETA	d_o	d_f	T_{ins}	s_{min}	c_{min}	d_b	h_1	h_{nom}	e	$s_{cr,N}$	$c_{cr,N}$	[--]
				[--]	[--]	[--]	[--]	[--]	[--]	[--]	[--]	[--]	[--]	[--]	[--]
HE-HC	HEHCM08	M8 x 25 Ø10	✓	10	9	11	200	150	35	28	25	8 – 13	200	150	EXHBM08C
	HEHCM10	M10 x 25 Ø12	✓	12	12	17	200	150	35	28	25	10 – 17	200	150	EXHBM10C
	HEHCM12	M12 x 25 Ø15	✓	15	14	38	200	150	35	29	25	12 – 21	200	150	EXHBM12C

5. INSTALLATION PROCEDURE

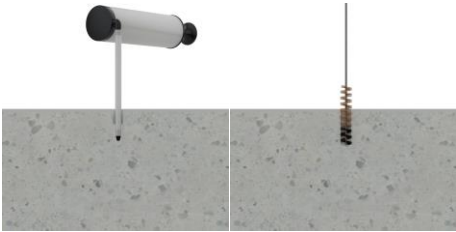
5.1. CONCRETE INSTALLATION

	<p>1. DRILL Check the concrete base is well compacted and porosity insignificant. Dry and wet drills allowed Drill at hammer or percussion position Respect specified diameter and depth.</p>
	<p>2. BLOW AND CLEAN Clean hole from dust and drill debris. Use air pump and brush</p>
	<p>3. INSTALLATION Introduce the anchor in the hole completely. Use hammer if necessary. The anchor must not stand out of the surface of the base material.</p>
	<p>4. EXPAND ANCHOR Insert the expansion tool into the inner cone of the anchor. Hammer until the setting tool is level with the anchor</p>

6. RESISTANCE IN CONCRETE

Resistances in concrete class C20/25 for an isolated anchor without spacing or concrete edge distance effects are indicated in the following table:

6.1 CHARACTERISTIC RESISTANCE [kN]

General parameters			Structural applications			Non Structural applications	
Family	Code	Size	Assessed	Tension	Shear	Assessed	Resistance to any direction
				N _{Rk}	V _{Rk}		F _{Rk}
HE-HO	HEHOM06	M6 x 25 Ø8	✓	6,15	6,15	✓	2,00
	HEHOM08	M8 x 30 Ø10	✓	8,08	8,08	✓	3,00
	HEHOM10	M10 x 40 Ø12	✓	12,45	<u>9,10</u>	✓	5,00
	HEHOM12	M12 x 50 Ø15	✓	17,39	17,39	✓	7,50
	HEHOM16	M16 x 65 Ø20	✓	25,78	<u>32,50</u>	✓	12,0
	HEHOM20	M20 x 80 Ø25	✓	35,20	<u>47,50</u>	✓	20,0
	HEHOM12D	M12 x 50 Ø16	--	17,39	17,39	✓	6,0
HE-NO	HENOM06	M6 x 25 Ø8	--	5,04	6,15	--	--
	HENOM08	M8 x 30 Ø10	--	6,63	8,08	--	--
	HENOM10	M10 x 40 Ø12	--	10,20	<u>9,10</u>	--	--
	HENOM12	M12 x 50 Ø15	--	14,26	17,39	--	--
	HENOM16	M16 x 65 Ø20	--	21,13	<u>32,50</u>	--	--
	HENOM20	M20 x 80 Ø25	--	28,85	<u>47,50</u>	--	--
HE-CL	HECLOM06	M6 x 25 Ø8	✓	6,15	6,15	✓	2,00
	HECLOM08	M8 x 30 Ø10	✓	8,08	8,08	✓	3,00
	HECLOM10	M10 x 40 Ø12	✓	12,45	<u>9,10</u>	✓	5,00
	HECLOM12	M12 x 50 Ø15	✓	17,39	17,39	✓	7,50
	HECLOM16	M16 x 65 Ø20	✓	25,78	<u>32,50</u>	✓	12,0
	HECLOM12D	M12 x 50 Ø16	--	17,39	17,39	✓	6,00
HE-A4	HEA4M06	M6 x 25 Ø8	--	2,50	2,50	✓	2,50
	HEA4M08	M8 x 30 Ø10	--	3,50	3,50	✓	3,50
	HEA4M10	M10 x 40 Ø12	--	3,50	3,50	✓	3,50
	HEA4M12	M12 x 50 Ø15	--	6,50	6,50	✓	6,50
	HEA4M16	M16 x 65 Ø20	--	12,50	12,50	✓	12,50
	HEA4M20	M20 x 80 Ø25	--	16,50	16,50	✓	16,50
HE-C4	HEC4M06	M6 x 25 Ø8	--	2,50	2,50	✓	2,50
	HEC4M08	M8 x 30 Ø10	--	3,50	3,50	✓	3,50
	HEC4M10	M10 x 40 Ø12	--	3,50	3,50	✓	3,50
	HEC4M12	M12 x 50 Ø15	--	6,50	6,50	✓	6,50
HE-NS	HENSM06	M6 x 25 Ø8	--	6,15	6,15	--	--
	HENSM08	M8 x 30 Ø10	--	8,08	8,08	--	--
	HENSM10	M10 x 40 Ø12	--	12,45	<u>9,10</u>	--	--
	HENSM12	M12 x 50 Ø15	--	17,39	17,39	--	--
	HENSM16	M16 x 65 Ø20	--	25,78	<u>32,50</u>	--	--
HE-HC	HEHCM08	M8 x 25 Ø10	--	--	--	✓	2,5
	HEHCM10	M10 x 25 Ø12	--	--	--	✓	4,0
	HEHCM12	M12 x 25 Ø15	--	--	--	✓	4,0

1 kN ≈ 100 kg

Values underlined and in italics show Steel failure, **bold** values concrete failure and other indicate pull out failure.

6.2 DESIGN RESISTANCE [kN]								
General parameters			Structural applications			Non Structural applications		
Family	Code	Size	Assessed	Tension	Shear	Assessed	Resistance to any direction	
				N _{Rk}	V _{Rk}		F _{Rk}	
HE-HO	HEHOM06	M6 x 25 Ø8	✓	3,42	4,10	✓	1,11	
	HEHOM08	M8 x 30 Ø10	✓	4,49	5,39	✓	1,67	
	HEHOM10	M10 x 40 Ø12	✓	5,93	<i>7,28</i>	✓	2,38	
	HEHOM12	M12 x 50 Ø15	✓	8,28	11,60	✓	3,57	
	HEHOM16	M16 x 65 Ø20	✓	12,28	<i>26,00</i>	✓	5,71	
	HEHOM20	M20 x 80 Ø25	✓	16,76	<i>38,00</i>	✓	9,52	
	HEHOM12D	M12 x 50 Ø16	--	8,28	11,60	✓	2,86	
HE-NO	HENOM06	M6 x 25 Ø8	--	2,40	4,10	--	--	
	HENOM08	M8 x 30 Ø10	--	3,15	5,39	--	--	
	HENOM10	M10 x 40 Ø12	--	4,86	<i>7,28</i>	--	--	
	HENOM12	M12 x 50 Ø15	--	6,79	11,60	--	--	
	HENOM16	M16 x 65 Ø20	--	10,06	<i>26,00</i>	--	--	
	HENOM20	M20 x 80 Ø25	--	13,74	<i>38,00</i>	--	--	
	HECLM06	M6 x 25 Ø8	✓	3,42	4,10	✓	1,11	
HE-CL	HECLM08	M8 x 30 Ø10	✓	4,49	5,39	✓	1,67	
	HECLM10	M10 x 40 Ø12	✓	5,93	<i>7,28</i>	✓	2,38	
	HECLM12	M12 x 50 Ø15	✓	8,28	11,60	✓	3,57	
	HECLM16	M16 x 65 Ø20	✓	12,28	<i>26,00</i>	✓	5,71	
	HECLM12D	M12 x 50 Ø16	--	8,28	11,60	✓	2,86	
	HE-A4	HEA4M06	M6 x 25 Ø8	--	1,19	1,19	✓	1,19
		HEA4M08	M8 x 30 Ø10	--	1,67	1,67	✓	1,67
HEA4M10		M10 x 40 Ø12	--	1,67	1,67	✓	1,67	
HEA4M12		M12 x 50 Ø15	--	3,10	3,10	✓	3,10	
HEA4M16		M16 x 65 Ø20	--	5,95	5,95	✓	5,95	
HEA4M20		M20 x 80 Ø25	--	7,86	7,86	✓	7,86	
HEC4M06		M6 x 25 Ø8	--	1,19	1,19	✓	1,19	
HE-C4	HEC4M08	M8 x 30 Ø10	--	1,67	1,67	✓	1,67	
	HEC4M10	M10 x 40 Ø12	--	1,67	1,67	✓	1,67	
	HEC4M12	M12 x 50 Ø15	--	3,10	3,10	✓	3,10	
	HEC4M16	M16 x 65 Ø20	--	5,95	5,95	✓	5,95	
HE-NS	HENSM06	M6 x 25 Ø8	--	3,42	4,10	--	--	
	HENSM08	M8 x 30 Ø10	--	4,49	5,39	--	--	
	HENSM10	M10 x 40 Ø12	--	5,93	<i>7,28</i>	--	--	
	HENSM12	M12 x 50 Ø15	--	8,28	11,60	--	--	
	HENSM16	M16 x 65 Ø20	--	12,28	<i>26,00</i>	--	--	
HE-HC	HEHCM08	M8 x 25 Ø10	--	--	--	✓	1,39	
	HEHCM10	M10 x 25 Ø12	--	--	--	✓	2,22	
	HEHCM12	M12 x 25 Ø15	--	--	--	✓	2,22	

1 kN ≈ 100 kg
 Values underlined and in italics show Steel failure, **bold** values concrete failure and other indicate pull out failure.

6.3 MAXIMUM LOADS RECOMMENDED [kN]

General parameters			Structural applications			Non-Structural applications	
Family	Code	Size	Assessed	Tension	Shear	Assessed	Resistance to any direction
				N _{Rk}	V _{Rk}		F _{Rk}
HE-HO	HEHOM06	M6 x 25 Ø8	✓	2,44	2,93	✓	0,79
	HEHOM08	M8 x 30 Ø10	✓	3,21	3,85	✓	1,19
	HEHOM10	M10 x 40 Ø12	✓	4,23	<u>5,20</u>	✓	1,70
	HEHOM12	M12 x 50 Ø15	✓	5,92	8,28	✓	2,55
	HEHOM16	M16 x 65 Ø20	✓	8,77	<u>18,57</u>	✓	4,08
	HEHOM20	M20 x 80 Ø25	✓	11,97	<u>27,14</u>	✓	6,80
	HEHOM12D	M12 x 50 Ø16	--	5,92	8,28	✓	1,19
HE-NO	HENOM06	M6 x 25 Ø8	--	1,71	2,93	--	--
	HENOM08	M8 x 30 Ø10	--	2,25	3,85	--	--
	HENOM10	M10 x 40 Ø12	--	3,47	<u>5,20</u>	--	--
	HENOM12	M12 x 50 Ø15	--	4,85	8,28	--	--
	HENOM16	M16 x 65 Ø20	--	7,19	<u>18,57</u>	--	--
	HENOM20	M20 x 80 Ø25	--	9,81	<u>27,14</u>	--	--
	HECLOM12D	M12 x 50 Ø16	--	5,92	8,28	✓	2,04
HE-CL	HECLOM06	M6 x 25 Ø8	✓	2,44	2,93	✓	0,79
	HECLOM08	M8 x 30 Ø10	✓	3,21	3,21	✓	1,19
	HECLOM10	M10 x 40 Ø12	✓	4,23	<u>5,20</u>	✓	1,70
	HECLOM12	M12 x 50 Ø15	✓	5,92	8,28	✓	2,55
	HECLOM16	M16 x 65 Ø20	✓	8,77	<u>18,57</u>	✓	4,08
	HECLOM12D	M12 x 50 Ø16	--	5,92	8,28	✓	2,04
	HEA4M12D	M12 x 50 Ø16	--	5,92	8,28	✓	2,04
HE-A4	HEA4M06	M6 x 25 Ø8	--	0,85	0,85	✓	0,85
	HEA4M08	M8 x 30 Ø10	--	1,19	1,19	✓	1,19
	HEA4M10	M10 x 40 Ø12	--	1,19	1,19	✓	1,19
	HEA4M12	M12 x 50 Ø15	--	2,21	2,21	✓	2,21
	HEA4M16	M16 x 65 Ø20	--	4,25	4,25	✓	4,25
	HEA4M20	M20 x 80 Ø25	--	5,61	5,61	✓	5,61
	HEA4M12D	M12 x 50 Ø16	--	5,92	8,28	✓	2,04
HE-C4	HEA4M06	M6 x 25 Ø8	--	0,85	0,85	✓	0,85
	HEA4M08	M8 x 30 Ø10	--	1,19	1,19	✓	1,19
	HEA4M10	M10 x 40 Ø12	--	1,19	1,19	✓	1,19
	HEA4M12	M12 x 50 Ø15	--	2,21	2,21	✓	2,21
	HEA4M16	M16 x 65 Ø20	--	4,25	4,25	✓	4,25
HE-NS	HENSM06	M6 x 25 Ø8	--	2,44	2,93	--	--
	HENSM08	M8 x 30 Ø10	--	3,21	3,85	--	--
	HENSM10	M10 x 40 Ø12	--	4,23	<u>5,20</u>	--	--
	HENSM12	M12 x 50 Ø15	--	5,92	8,28	--	--
	HENSM16	M16 x 65 Ø20	--	8,77	<u>18,57</u>	--	--
	HEHCM12D	M12 x 50 Ø16	--	5,92	8,28	✓	2,04
HE-HC	HEHCM08	M8 x 25 Ø10	--	--	--	✓	0,99
	HEHCM10	M10 x 25 Ø12	--	--	--	✓	1,59
	HEHCM12	M12 x 25 Ø15	--	--	--	✓	1,59

1 kN ≈ 100 kg
 Values underlined and in italics show Steel failure, **bold** values concrete failure and other indicate pull out failure.

7. RESISTANCES

Resistance in hollow core slabs from C30/37 to C50/60 for an isolated anchor without spacing or concrete edge distance effects are indicated in the following table:

7.1 RESISTANCES

General parameters				Load in all directions [F _{Rk}] (Non-Structural applications)		
Family	Code	Size	Assessed	CHARACTERISTIC [kN]	DESIGN [kN]	MAXIMUM RECOMMENDED LOADS [kN]
HE-HC	HEHCM08	M8 x 25 Ø10	✓	5,5	3,06	2,18
	HEHCM10	M10 x 25 Ø12	✓	6,0	2,86	2,04
	HEHCM12	M12 x 25 Ø15	✓	6,5	3,10	2,21

1 kN ≈ 100 kg

8. OFFICIAL DOCUMENTATION

The following documents are available on our official website www.indexfix.com:

- European assessment ETA 14/0135 for Installation in non-cracked concrete according to guideline EAD 330232-00-0601, option 7, from M6 to M20.
- European assessment ETA 14/0068 for non-structural applications in redundant systems in cracked and uncracked concrete according to guideline EAD 330747-00-0601, option 7, from M6 to M20.
- Declaration of performance DoP HE.
- Certificate VdS CEA 4001:2021-01(07) *Guidelines for sprinklers systems. Planning and installation for applications of water extinguishing systems on concrete elements* from M8 to M20.
- Certificate FM *Pipe Hanger Components for Automatic Sprinkler Systems* from M10 to M16
- Available for the anchor design software INDEXcal.