

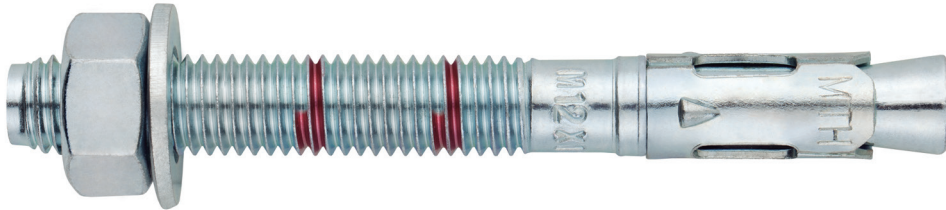

Through-bolt expansion anchor with controlled torque, for use in non cracked concrete

MTH

ETA Assessed Option 7. Zinc-plated shaft. Zinc-plated clip.



PRODUCT INFORMATION

DESCRIPTION

Metallic anchor, with male thread, expansion by controlled torque.

OFFICIAL DOCUMENTATION

- AVCP-1219-CPR-00063.
- ETA 05/0242 option 7.
- Declaration of Performance DoP MTH.
- MFPA Fire Protection Assessment.

SIZES

M6x60 to M20x270.

DESIGN LOAD RANGE

From 5,3 to 34,3 kN [standard depth].
From 6,7 to 21,3 kN [reduced depth].



BASE MATERIAL

Concrete class from C20/25 to C50/60 non-cracked.



Stone

Concrete

Reinforced concrete

ASSESSMENTS

- Option 7 [Non-cracked concrete].



CHARACTERISTICS AND BENEFITS

- Easy installation.
- Use in non-cracked concrete.
- Use for medium-heavy duty loads.
- Pre-installation or through the drill-hole of the fixture.
- Variety of lengths and diameters: flexibility in assembly.
- For static and quasi-static loads.
- Two installation depths in M8, M10, M12, M16 and M20, allowing the use in thick anchor plates or in low thickness base materials.
- Available at INDEXcal.



MATERIALS

Shaft: Cold-formed carbon steel, zinc-plated $\geq 5 \mu\text{m}$.

Washer: DIN 125 or DIN 9021, zinc-plated $\geq 5 \mu\text{m}$.

Nut: DIN 934, zinc-plated $\geq 5 \mu\text{m}$.

Clip: Cold-formed carbon steel, zinc-plated $\geq 40 \mu\text{m}$.



APPLICATIONS

- Anchor plates.
- Supports.
- Structures.
- Shelving
- Urban fitments.
- Protective fences.
- Catenaries.
- Elevators.
- Scaffolding fixing.





MECHANICAL PROPERTIES

			M6	M8	M10	M12	M14	M16	M20
Cone area section									
A_s	(mm ²)	Cone area section	14,5	25,5	46,5	68,0	100,2	122,6	216,3
$f_{u,s}$	(N/mm ²)	Characteristic tension resistance	510	510	510	490	490	490	460
$f_{y,s}$	(N/mm ²)	Yield strength	440	440	440	410	410	410	375
Threaded area section									
A_s	(mm ²)	Cone area section	20,1	36,6	58,0	84,3	115,0	157,0	245,0
$f_{u,s}$	(N/mm ²)	Characteristic tension resistance	510	510	510	490	490	490	490
$f_{y,s}$	(N/mm ²)	Yield Strength	440	440	440	410	410	410	410

INSTALLATION DATA

SIZE			M6	M8	M10	M12	M14	M16	M20	
Code			AH06XXX	AH08XXX	AH10XXX	AH12XXX	AH14XXX	AH16XXX	AH20XXX	
d_0	Nominal diameter of drill bit	[mm]	6	8	10	12	14	16	20	
T_{ins}	Installation torque moment	[Nm]	7	20	35	60	90	120	240	
$d_f \leq$	Diameter of clearance hole in the fixture	[mm]	7	9	12	14	16	18	22	
Standard depth	h_1	Minimum drill hole depth	[mm]	55	65	75	85	100	110	135
	h_{nom}	Installation depth	[mm]	49,5	59,5	66,5	77	91	103,5	125
	h_{ef}	Effective embedment depth	[mm]	40	48	55	65	75	84	103
	h_{min}	Minimum base material thickness	[mm]	100	100	110	130	150	168	206
	t_{fix}	Maximum thickness of fixture*	[mm]	L - 58	L - 70	L - 80	L - 92	L - 108	L - 122	L - 147
	$s_{cr,N}$	Critical spacing	[mm]	120	144	165	195	225	252	309
	$c_{cr,N}$	Critical edge distance	[mm]	60	72	83	98	113	126	155
	$s_{cr,sp}$	Critical distance (splitting)	[mm]	160	192	220	260	300	280	360
	$c_{cr,sp}$	Critical edge distance (splitting)	[mm]	80	96	110	130	150	140	180
	Reduced depth	h_1	Minimum drill hole depth	[mm]	-	50	60	70	-	90
h_{nom}		Installation depth	[mm]	-	46,5	53,5	62	-	84,5	97
h_{ef}		Effective embedment depth	[mm]	-	35	42	50	-	65	75
h_{min}		Minimum base material thickness	[mm]	-	100	100	100	-	130	150
t_{fix}		Maximum thickness of fixture*	[mm]	-	L-57	L-67	L-77	-	L - 103	L - 121
$s_{cr,N}$		Critical spacing	[mm]	-	105	126	150	-	195	225
$c_{cr,N}$		Critical edge distance	[mm]	-	53	63	75	-	98	113
$s_{cr,sp}$		Critical distance (splitting)	[mm]	-	140	168	200	-	260	300
$c_{cr,sp}$		Critical edge distance (splitting)	[mm]	-	70	84	100	-	130	150
s_{min}		Minimum spacing	[mm]	35	40	50	70	80	90	135
c_{min}	Minimum edge distance	[mm]	35	40	50	70	80	90	135	
SW	Installation wrench		10	13	17	19	22	24	30	

*L = Total anchor length

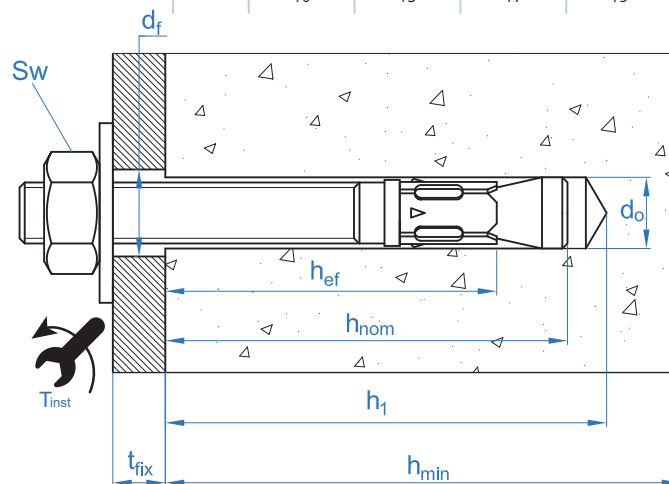



Code	INSTALLATION PRODUCTS
	Hammer drill
BHDSXXXXX	Concrete Drill bits
MOBOMBA	Blow pump
MORCEPKIT	Cleaning Brush
DOMTAXX	Installation hammering tool
	Torque wrench
	Hexagonal socket

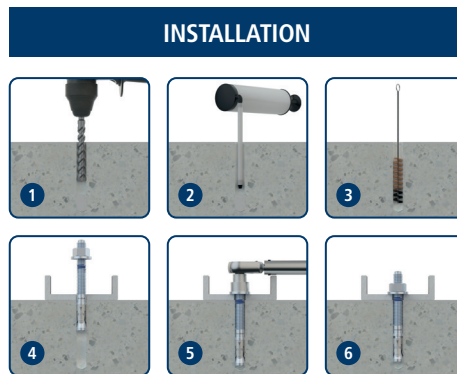

Resistances in C20/25 concrete for an isolated anchor, without effects of edge distance or spacing

Characteristic Resistance N_{Rk} y V_{Rk}																			
TENSION								SHEAR											
Size		M6	M8	M10	M12	M14	M16	M20	Size		M6	M8	M10	M12	M14	M16	M20		
N_{Rk}	Standard depth	[kN]	7,4	13,0	19,0	25,8	32,0	37,9	51,4	V_{Rk}	Standard depth	[kN]	5,1	9,3	14,7	20,6	28,1	38,4	56,3
N_{Rk}	Reduced depth	[kN]	-	10,0	13,4	17,4	-	25,8	32,0	V_{Rk}	Reduced depth	[kN]	-	10,2	13,4	17,4	-	38,4	63,9

Design Resistance N_{Rd} y V_{Rd}																			
TENSION								SHEAR											
Size		M6	M8	M10	M12	M14	M16	M20	Size		M6	M8	M10	M12	M14	M16	M20		
N_{Rd}	Standard depth	[kN]	5,3	9,3	12,7	17,2	21,3	25,2	34,3	V_{Rd}	Standard depth	[kN]	4,1	7,4	11,8	16,5	22,5	30,7	45,0
N_{Rd}	Reduced depth	[kN]	-	6,7	8,9	11,6	-	17,2	21,3	V_{Rd}	Reduced depth	[kN]	-	6,8	8,9	11,6	-	30,7	42,6

Maximum Loads Recommended N_{rec} y V_{rec}																			
TENSION								SHEAR											
Size		M6	M8	M10	M12	M14	M16	M20	Size		M6	M8	M10	M12	M14	M16	M20		
N_{rec}	Standard depth	[kN]	3,8	6,6	9,0	12,3	15,2	18,0	24,5	V_{rec}	Standard depth	[kN]	2,9	5,3	8,4	11,8	16,1	21,9	32,2
N_{rec}	Reduced depth	[kN]	-	4,8	6,4	8,3	-	12,3	15,2	V_{rec}	Reduced depth	[kN]	-	4,9	6,4	8,3	-	21,9	30,4

Simplified calculation method

European Technical Assessment 05/0242

Simplified version of the calculation method according to Eurocode 2 EN 1992-4. Resistance is calculated according to the data shown in assessment 05/0242.

- Influence of concrete strength.
- Influence of edge distance.
- Influence of spacing between anchors.
- Influence of reinforcements.
- Influence of base material thickness.
- Influence of load application angle.
- Valid for a group of two anchors.



INDEXcal

For a more accurate calculation and to take more constructive provisions into account, we recommend using our calculation program INDEXcal. It may be easily downloaded from our website www.indexfix.com



MTH

TENSION LOADS

- Steel design resistance: $N_{Rd,s}$
- Pull-out design resistance: $N_{Rd,p} = N_{Rd,p}^o \cdot \psi_c$
- Concrete cone design resistance: $N_{Rd,c} = N_{Rd,c}^o \cdot \psi_b \cdot \psi_{s,N} \cdot \psi_{c,N} \cdot \psi_{re,N}$
- Concrete splitting design resistance: $N_{Rd,sp} = N_{Rd,c}^o \cdot \psi_b \cdot \psi_{s,sp} \cdot \psi_{c,sp} \cdot \psi_{re,N} \cdot \psi_{h,sp}$

Steel Design resistance									
$N_{Rd,s}$									
Size			M6	M8	M10	M12	M14	M16	M20
N_{Rd}^o	Standard depth	[kN]	5,3	9,3	16,9	23,8	35,1	42,9	71,1

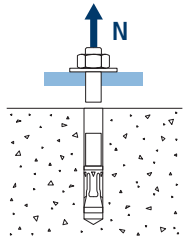

Pull-out design resistance									
$N_{Rd,p} = N_{Rd,p}^o \cdot \psi_c$									
Size			M6	M8	M10	M12	M14	M16	M20
$N_{Rd,p}^o$	Standard depth	[kN]	-*	-*	12,6	-*	-*	-*	-*
$N_{Rd,p}^o$	Reduced depth	[kN]	-	6,6	-*	-*	-	-*	-*

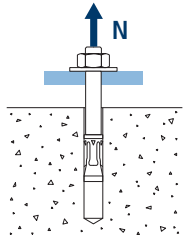

* Pull-out failure is not decisive.

Concrete cone design resistance									
$N_{Rd,c} = N_{Rd,c}^o \cdot \psi_b \cdot \psi_{s,N} \cdot \psi_{c,N} \cdot \psi_{re,N}$									
Concrete splitting design resistance*									
$N_{Rd,sp} = N_{Rd,c}^o \cdot \psi_b \cdot \psi_{s,sp} \cdot \psi_{c,sp} \cdot \psi_{re,N} \cdot \psi_{h,sp}$									
Size			M6	M8	M10	M12	M14	M16	M20
$N_{Rd,c}^o$	Standard depth	[kN]	8,3	10,9	13,4	17,2	21,3	25,2	34,3
$N_{Rd,c}^o$	Reduced depth	[kN]	-	6,8	8,9	11,6	-	17,2	21,3

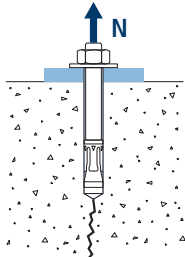
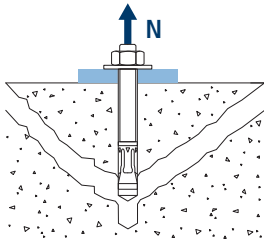

* Concrete splitting design resistance must only be considered for non-cracked concrete.



MTH

Coefficients of influence

Influence of concrete strength resistance in pul-out failure Ψ_c

		M6	M8	M10	M12	M14	M16	M20
Ψ_c	C 20/25	1,00						
	C 30/37	1,22						
	C 40/50	1,41						
	C 50/60	1,58						

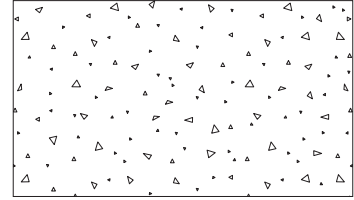
Influence of concrete strength in concret cone and splitting failure Ψ_b

		M6	M8	M10	M12	M14	M16	M20
Ψ_b	C 20/25	1,00						
	C 30/37	1,22						
	C 40/50	1,41						
	C 50/60	1,58						

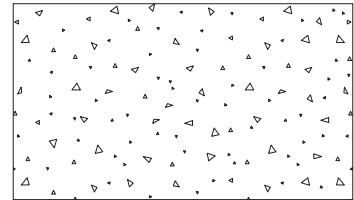

$$\Psi_b = \sqrt{\frac{f_{ck,cube}}{25}} \geq 1$$



MTH

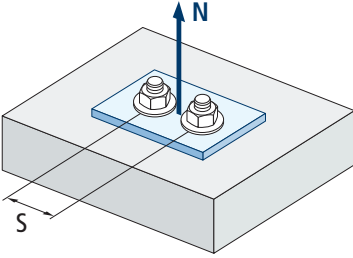

$$\psi_{s,N} = 0,5 + \frac{s}{2 \cdot s_{cr,N}} \leq 1$$

Influence of spacing (concrete cone) $\psi_{s,N}$							
s [mm]	MTH. Standard depth						
	M6	M8	M10	M12	M14	M16	M20
35	0,65						
40	0,67	0,64					
50	0,71	0,67	0,65				
55	0,73	0,69	0,67				Invalid value
60	0,75	0,71	0,68				
65	0,77	0,73	0,70				
70	0,79	0,74	0,71	0,68			
80	0,83	0,78	0,74	0,71			
85	0,85	0,80	0,76	0,72	0,69		
90	0,88	0,81	0,77	0,73	0,70		
100	0,92	0,85	0,80	0,76	0,72	0,70	
105	0,94	0,86	0,82	0,77	0,73	0,71	
110	0,96	0,88	0,83	0,78	0,74	0,72	
120	1,00	0,92	0,86	0,81	0,77	0,74	
125		0,93	0,88	0,82	0,78	0,75	
126		0,94	0,88	0,82	0,78	0,75	
128		0,94	0,89	0,83	0,78	0,75	
130		0,95	0,89	0,83	0,79	0,76	
135		0,97	0,91	0,85	0,80	0,77	0,72
144		1,00	0,94	0,87	0,82	0,79	0,73
150			0,95	0,88	0,83	0,80	0,74
165			1,00	0,92	0,87	0,83	0,77
170				0,94	0,88	0,84	0,78
180				0,96	0,90	0,86	0,79
195				1,00	0,93	0,89	0,82
200					0,94	0,90	0,82
210					0,97	0,92	0,84
220					0,99	0,94	0,86
225					1,00	0,95	0,86
252						1,00	0,91
255							0,91
260							0,92
300							0,99
309							1,00
s [mm]	MTH. Reduced depth						
	M6	M8	M10	M12	M14	M16	M20
40		0,69					
50		0,74	0,70				
55		0,76	0,72				
60		0,79	0,74				Invalid value
65		0,81	0,76				
70		0,83	0,78	0,73			
80		0,88	0,82	0,77			
85		0,90	0,84	0,78			
90		0,93	0,86	0,80			
100		0,98	0,90	0,83		0,73	
105		1,00	0,92	0,85		0,76	
110			0,94	0,87		0,77	
120			0,98	0,90		0,78	
125			1,00	0,92		0,81	
126			1,00	0,92		0,82	
128				0,93		0,82	
130				0,93		0,83	
135				0,95		0,83	
144				0,98		0,85	0,80
150				1,00		0,87	0,82
165						0,88	0,83
170						0,92	0,87
180						0,94	0,88
195						0,96	0,90
200						1,00	0,93
210							0,94
220							0,97
225							0,99
252							1,00
							Value without reduction = 1



MTH

Influence of spacing (concrete splitting) $\psi_{s,sp}$							
s [mm]	MTH. Standard depth						
	M6	M8	M10	M12	M14	M16	M20
35	0,61						
40	0,63	0,60					
50	0,66	0,63	0,61				
55	0,67	0,64	0,63				
60	0,69	0,66	0,64				
65	0,70	0,67	0,65				
70	0,72	0,68	0,66	0,63			
80	0,75	0,71	0,68	0,65	0,63		
85	0,77	0,72	0,69	0,66	0,64		
90	0,78	0,73	0,70	0,67	0,65	0,66	
100	0,81	0,76	0,73	0,69	0,67	0,68	
110	0,84	0,79	0,75	0,71	0,68	0,70	
125	0,89	0,83	0,78	0,74	0,71	0,72	
128	0,90	0,83	0,79	0,75	0,71	0,73	
135	0,92	0,85	0,81	0,76	0,73	0,74	0,69
140	0,94	0,86	0,82	0,77	0,73	0,75	0,69
150	0,97	0,89	0,84	0,79	0,75	0,77	0,71
160	1,00	0,92	0,86	0,81	0,77	0,79	0,72
165		0,93	0,88	0,82	0,78	0,79	0,73
168		0,94	0,88	0,82	0,78	0,80	0,73
180		0,97	0,91	0,85	0,80	0,82	0,75
192		1,00	0,94	0,87	0,82	0,84	0,77
200			0,95	0,88	0,83	0,86	0,78
210			0,98	0,90	0,85	0,88	0,79
220			1,00	0,92	0,87	0,89	0,81
260				1,00	0,93	0,96	0,86
280					0,97	1,00	0,89
288					0,98		0,90
300					1,00		0,92
336							0,97
350							0,99
360							1,00
MTH. Reduced depth							
s [mm]	M6	M8	M10	M12	M14	M16	M20
40		0,64					
50		0,68	0,65				
55		0,70	0,66				
60		0,71	0,68				
65		0,73	0,69				
70		0,75	0,71	0,68			
80		0,79	0,74	0,70			
85		0,80	0,75	0,71			
90		0,82	0,77	0,73		0,67	
100		0,86	0,80	0,75		0,69	
110		0,89	0,83	0,78		0,71	
125		0,95	0,87	0,81		0,74	
128		0,96	0,88	0,82		0,75	
135		0,98	0,90	0,84		0,76	0,73
140		1,00	0,92	0,85		0,77	0,73
150			0,95	0,88		0,79	0,75
160			0,98	0,90		0,81	0,77
165			0,99	0,91		0,82	0,78
168			1,00	0,92		0,82	0,78
180				0,95		0,85	0,80
192				0,98		0,87	0,82
200				1,00		0,88	0,83
210						0,90	0,85
220						0,92	0,87
260						1,00	0,93
280							0,97
288							0,98
300							1,00

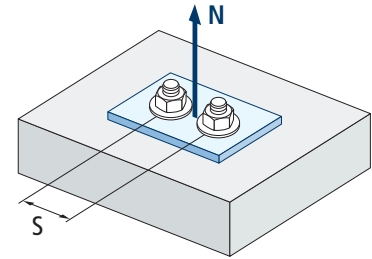

$$\psi_{s,sp} = 0,5 + \frac{S}{2 \cdot S_{cr,sp}} \leq 1$$

Value without reduction = 1

Value without reduction = 1



MTH

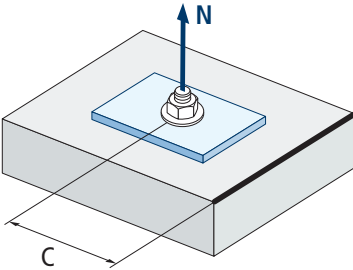

$$\psi_{c,sp} = 0,35 + \frac{0,5 \cdot c}{c_{cr,sp}} + \frac{0,15 \cdot c^2}{c_{cr,sp}^2} \leq 1$$

Influence of concrete edge distance (splitting) $\psi_{c,sp}$							
c [mm]	MTH. Standard depth						
	M6	M8	M10	M12	M14	M16	M20
35	0,60						
40	0,64	0,58					
50	0,72	0,65	0,61				
60	0,81	0,72	0,67				
65	0,86	0,76	0,70				
70	0,90	0,79	0,73	0,66			
75	0,95	0,83	0,76	0,69			
80	1,00	0,87	0,79	0,71	0,66		
83		0,89	0,81	0,73	0,67		
84		0,90	0,82	0,74	0,68		
85		0,91	0,83	0,74	0,68		
90		0,95	0,86	0,77	0,70	0,73	
96		1,00	0,90	0,80	0,73	0,76	
100			0,93	0,82	0,75	0,78	
105			0,96	0,85	0,77	0,81	
110			1,00	0,88	0,80	0,84	
125				0,97	0,87	0,92	
128				0,99	0,89	0,93	
130				1,00	0,90	0,94	
135					0,92	0,97	0,81
140					0,95	1,00	0,83
144					0,97		0,85
150					1,00		0,87
168							0,95
175							0,98
180							1,00

MTH. Reduced depth							
c [mm]	M6	M8	M10	M12	M14	M16	M20
	40		0,68				
50		0,78	0,70				
60		0,89	0,78				
65		0,94	0,83				
70		1,00	0,87	0,77			
75			0,92	0,81			
80			0,96	0,85			
83			0,99	0,87			
84			1,00	0,88			
85				0,88			
90				0,92		0,77	
96				0,97		0,80	
100				1,00		0,82	
105						0,85	
110						0,88	
125						0,97	
128						0,99	
130						1,00	
135							0,92
144							0,97
150							1,00



MTH

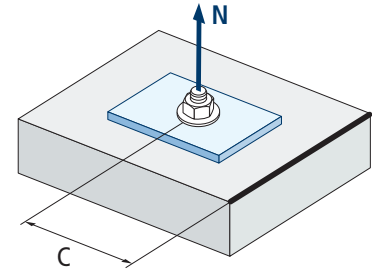

$$\psi_{c,N} = 0,35 + \frac{0,5 \cdot c}{C_{cr,N}} + \frac{0,15 \cdot c^2}{C_{cr,N}^2} \leq 1$$

Influence of concrete edge distance (concrete cone) $\psi_{c,N}$							
c [mm]	MTH. Standard depth						
	M6	M8	M10	M12	M14	M16	M20
35	0,69						
40	0,75	0,67					
50	0,87	0,77	0,71				Invalid value
53	0,91	0,80	0,73				
60	1,00	0,87	0,79				
63		0,90	0,82				
65		0,92	0,83				
70		0,98	0,88	0,78			
72		1,00	0,90	0,80			
75			0,92	0,82			
80			0,97	0,86	0,78		
83			1,00	0,88	0,80		
85				0,90	0,81		
90				0,94	0,84	0,78	
98				1,00	0,90	0,83	
100					0,91	0,84	
105					0,94	0,87	
110					0,98	0,90	
113					1,00	0,92	
125						0,99	
126						1,00	
128							Value without reduction = 1
135							0,90
150							0,97
155							1,00

MTH. Reduced depth							
c [mm]	M6	M8	M10	M12	M14	M16	M20
	40		0,81				
50		0,96	0,84				
53		1,00	0,88				Invalid value
60			0,96				
63			1,00				
65							
70				0,95			
72				0,97			
75				1,00			
80							
83							
85							
90						0,94	
98						1,00	
100							
105							
110							
113							
125							Value without reduction = 1
126							
128							
135							1,00



MTH

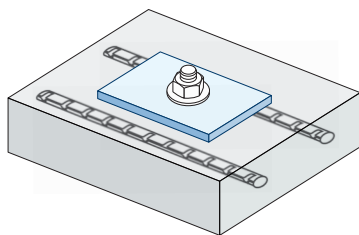

$$\Psi_{re,N} = 0,5 + \frac{h_{ef}}{200} \leq 1$$

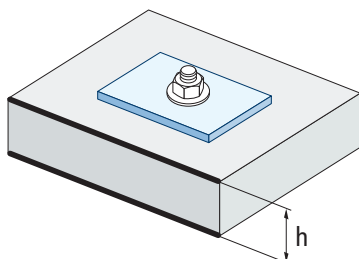

Influence of reinforcements $\Psi_{re,N}$							
$\Psi_{re,N}$	MTH. Standard depth						
	M6	M8	M10	M12	M14	M16	M20
	0,70	0,74	0,77	0,82	0,87	0,92	1,00
$\Psi_{re,N}$	MTH. Reduced depth						
	M6	M8	M10	M12	M14	M16	M20
	-	0,67	0,71	0,75	-	0,83	0,88

*This factor only applies for a high density of reinforcements. If in the area of the anchor there are reinforcements with a distancing of ≥ 150 mm (any diameter) or with a diameter ≤ 10 mm and a distancing of ≥ 100 mm, a $f_{re,N} = 1$ factor may be applied.

Influence of base material thickness $\Psi_{h,sp}$										
$\Psi_{h,sp}$	MTH									
	h/h _{ef}	2,00	2,20	2,40	2,60	2,80	3,00	3,20	3,40	3,60
$\Psi_{h,sp}$	1,00	1,07	1,13	1,19	1,25	1,31	1,37	1,42	1,48	1,50

$$\Psi_{h,sp} = \left(\frac{h}{2 \cdot h_{ef}} \right)^{2/3} \leq 1,5$$

SHEAR LOADS

- Steel design resistance without lever arm: $V_{Rd,s}$
- Pry-out design resistance: $V_{Rd,cp} = k \cdot N_{Rd,c}^o$
- Concrete edge design resistance: $V_{Rd,c} = V_{Rd,c}^o \cdot \Psi_b \cdot \Psi_{se,V} \cdot \Psi_{c,V} \cdot \Psi_{re,V} \cdot \Psi_{\alpha,V} \cdot \Psi_{h,V}$

Steel design resistance									
$V_{Rd,s}$									
Size			M6	M8	M10	M12	M14	M16	M20
$V_{Rd,s}$	Standard depth	[kN]	4,1	7,4	11,8	16,5	22,5	30,7	45,0
$V_{Rd,s}$	Reduced depth	[kN]	-	7,4	11,8	16,5	-	30,7	45,0

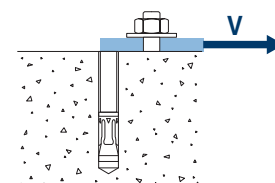

Pry-out design resistance*								
$V_{Rd,cp} = k \cdot N_{Rd,c}^o$								
Size		M6	M8	M10	M12	M14	M16	M20
k	(Standard depth)	1	1	1	2	2	2	2
k	(Reduced depth)	-	1	1	2	-	2	2

* $N_{Rd,c}^o$ Concrete cone design resistance for tension loads

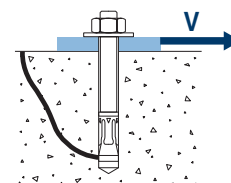

Concrete edge resistance									
$V_{Rd,c} = V_{Rd,c}^o \cdot \Psi_b \cdot \Psi_{se,V} \cdot \Psi_{c,V} \cdot \Psi_{re,V} \cdot \Psi_{\alpha,V} \cdot \Psi_{h,V}$									
Size			M6	M8	M10	M12	M14	M16	M20
$V_{Rd,c}^o$	Standard depth	[kN]	4,6	6,2	7,7	10,2	12,9	15,6	21,8
$V_{Rd,c}^o$	Reduced depth	[kN]	-	3,6	4,9	6,5	-	10,1	12,8

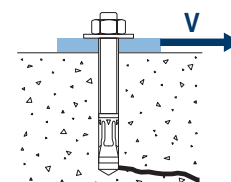



MTH

Coefficients of influence

Influence of concrete strength in concrete edge failure Ψ_b

		M6	M8	M10	M12	M14	M16	M20	
Ψ_b	C 20/25	1,00							
	C 30/37	1,22							
	C 40/50	1,41							
	C 50/60	1,55							

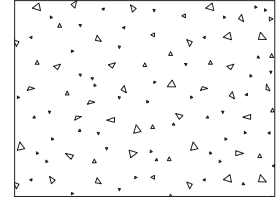

$$\Psi_b = \sqrt{\frac{f_{ck,cube}}{25}} \geq 1$$

Influence of edge distance and spacing $\Psi_{se,V}$

FOR ONE ANCHOR ONLY

c/h_{ef}	0,50	0,75	1,00	1,25	1,50	1,75	2,00	2,25	2,50	2,75	3,00	3,25	3,50	3,75	4,00	4,50	5,00
Isolated	0,35	0,65	1,00	1,40	1,84	2,32	2,83	3,38	3,95	4,56	5,20	5,86	6,55	7,26	8,00	9,55	11,18

FOR TWO ANCHORS

c/h_{ef}	0,50	0,75	1,00	1,25	1,50	1,75	2,00	2,25	2,50	2,75	3,00	3,25	3,50	3,75	4,00	4,50	5,00	
s/c	1,0	0,24	0,43	0,67	0,93	1,22	1,54	1,89	2,25	2,64	3,04	3,46	3,91	4,37	4,84	5,33	6,36	7,45
	1,5	0,27	0,49	0,75	1,05	1,38	1,74	2,12	2,53	2,96	3,42	3,90	4,39	4,91	5,45	6,00	7,16	8,39
	2,0	0,29	0,54	0,83	1,16	1,53	1,93	2,36	2,81	3,29	3,80	4,33	4,88	5,46	6,05	6,67	7,95	9,32
	2,5	0,32	0,60	0,92	1,28	1,68	2,12	2,59	3,09	3,62	4,18	4,76	5,37	6,00	6,66	7,33	8,75	10,25
	≥3,0	0,35	0,65	1,00	1,40	1,84	2,32	2,83	3,38	3,95	4,56	5,20	5,86	6,55	7,26	8,00	9,55	11,18

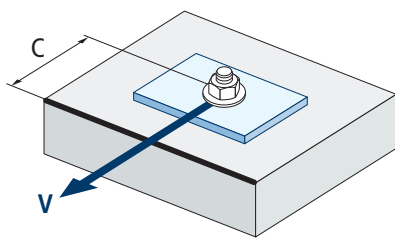

$$\Psi_{se,V} = \left(\frac{c}{h_{ef}}\right)^{1,5}$$

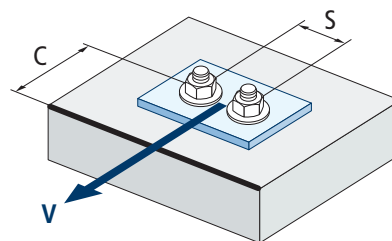

$$\Psi_{se,V} = \left(\frac{c}{h_{ef}}\right)^{1,5} \cdot \left(1 + \frac{s}{3 \cdot c}\right) \cdot 0,5 \leq \left(\frac{c}{h_{ef}}\right)^{1,5}$$



MTH

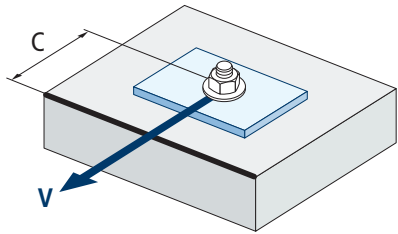

$$\psi_{c,v} = \left(\frac{d}{c} \right)^{0,20}$$

Influence of concrete edge distance $\psi_{c,v}$							
c [mm]	MTH						
	M6	M10	M10	M12	M14	M16	M20
35	0,70						
40	0,68	0,72					
45	0,67	0,71					
50	0,65	0,69	0,72				
55	0,64	0,68	0,71				
60	0,63	0,67	0,70				
70	0,61	0,65	0,68	0,70			
80	0,60	0,63	0,66	0,68	0,71		
85	0,59	0,62	0,65	0,68	0,70		
90	0,58	0,62	0,64	0,67	0,69	0,71	
100	0,57	0,60	0,63	0,65	0,67	0,69	
105	0,56	0,60	0,62	0,65	0,67	0,69	
110	0,56	0,59	0,62	0,64	0,66	0,68	
120	0,55	0,58	0,61	0,63	0,65	0,67	
125	0,54	0,58	0,60	0,63	0,65	0,66	
128	0,54	0,57	0,60	0,62	0,64	0,66	
130	0,54	0,57	0,60	0,62	0,64	0,66	
135	0,54	0,57	0,59	0,62	0,64	0,65	0,68
140	0,53	0,56	0,59	0,61	0,63	0,65	0,68
150	0,53	0,56	0,58	0,60	0,62	0,64	0,67
160	0,52	0,55	0,57	0,60	0,61	0,63	0,66
170	0,51	0,54	0,57	0,59	0,61	0,62	0,65
175	0,51	0,54	0,56	0,59	0,60	0,62	0,65
180	0,51	0,54	0,56	0,58	0,60	0,62	0,64
190	0,50	0,53	0,55	0,58	0,59	0,61	0,64
200	0,50	0,53	0,55	0,57	0,59	0,60	0,63
210	0,49	0,52	0,54	0,56	0,58	0,60	0,62
220	0,49	0,52	0,54	0,56	0,58	0,59	0,62
230	0,48	0,51	0,53	0,55	0,57	0,59	0,61
240	0,48	0,51	0,53	0,55	0,57	0,58	0,61
250	0,47	0,50	0,53	0,54	0,56	0,58	0,60
260	0,47	0,50	0,52	0,54	0,56	0,57	0,60
270	0,47	0,49	0,52	0,54	0,55	0,57	0,59
280	0,46	0,49	0,51	0,53	0,55	0,56	0,59
290	0,46	0,49	0,51	0,53	0,55	0,56	0,59
300	0,46	0,48	0,51	0,53	0,54	0,56	0,58



Influence of reinforcements $\Psi_{re,v}$			
	Without perimetral reinforcements	Perimetral reinforcements $\geq \text{Ø}12 \text{ mm}$	Perimetral reinforcements with brackets $\leq 100 \text{ mm}$
Non-cracked concrete	1	1	1

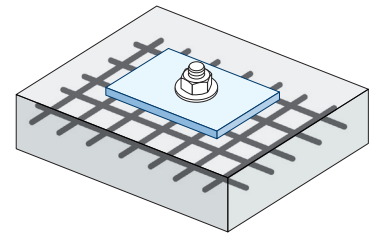

Influence of load application angle $\Psi_{\alpha,v}$										
Angle, $\alpha(^{\circ})$	0°	10°	20°	30°	40°	50°	60°	70°	80°	90°
$\Psi_{\alpha,v}$	1,00	1,01	1,05	1,13	1,24	1,40	1,64	1,97	2,32	2,50

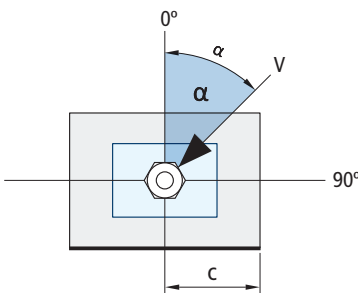

$$\Psi_{\alpha,v} = \sqrt{\frac{1}{(\cos \alpha_v)^2 + \left(\frac{\sin \alpha_v}{2,5}\right)^2}} \geq 1$$

Influence of base material thickness $\Psi_{h,v}$										
	MTH									
h/c	0,15	0,30	0,45	0,60	0,75	0,90	1,05	1,20	1,35	$\geq 1,5$
$\Psi_{h,v}$	0,32	0,45	0,55	0,63	0,71	0,77	0,84	0,89	0,95	1,00

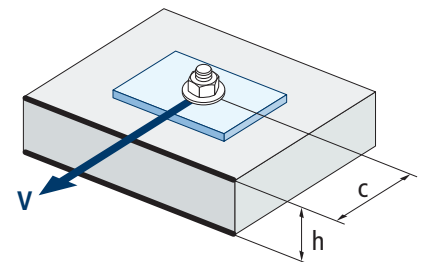

$$\Psi_{h,v} = \left(\frac{h}{1,5 \cdot c}\right)^{0,5} \geq 1,0$$



MTH

FIRE RESISTANCE

Characteristic Resistance*														
	TENSION							SHEAR						
	M6	M8	M10	M12	M14	M16	M20	M6	M8	M10	M12	M14	M16	M20
RF30	-	0,8	1,5	2,4	3,3	4,5	7,0	-	0,8	1,5	2,4	3,3	4,5	7,0
RF60	-	0,7	1,2	2,0	2,7	3,6	5,7	-	0,7	1,2	2,0	2,7	3,6	5,7
RF90	-	0,5	1,0	1,5	2,0	2,7	4,3	-	0,5	1,0	1,5	2,0	2,7	4,3
RF120	-	0,5	0,8	1,2	1,7	2,3	3,6	-	0,5	0,8	1,2	1,7	2,3	3,6

*The safety factor for design resistance under fire exposure is $\gamma_{M,n}=1$ (in absence of other national regulations). As a result the Characteristic Resistance is the same as Design Resistance.

Maximum Load Recommended														
	TENSION							SHEAR						
	M6	M8	M10	M12	M14	M16	M20	M6	M8	M10	M12	M14	M16	M20
RF30	-	0,6	1,1	1,7	2,4	3,2	5,0	-	0,6	1,1	1,7	2,4	3,2	5,0
RF60	-	0,5	0,9	1,4	1,9	2,6	4,0	-	0,5	0,9	1,4	1,9	2,6	4,0
RF90	-	0,4	0,7	1,1	1,4	2,0	3,1	-	0,4	0,7	1,1	1,4	2,0	3,1
RF120	-	0,3	0,6	0,9	1,2	1,6	2,6	-	0,3	0,6	0,9	1,2	1,6	2,6

• Fire resistance values are not covered by ETA.

RANGE

Code	Size	Maximum thckn. of fixture	Axle letter (length)			Code	Size	Maximum thckn. of fixture	Axle letter (length)		
AH06060	M6 x 60 Ø6	2	B	200	1.200	AH10170	M10 x 170 Ø10	90	K	50	200
AH06070	M6 x 70 Ø6	12	C	200	1.200	AH10210	M10 x 210 Ø10	130	N	50	150
AH06080	M6 x 80 Ø6	22	D	200	1.200	AH10230	M10 x 230 Ø10	150	P	50	100
AH06090	M6 x 90 Ø6	32	E	200	1.200	AH12090	M12 x 90 Ø12	13	E	50	200
AH06100	M6 x 100 Ø6	42	E	200	800	AH12100	M12 x 100 Ø12	8	E	50	200
AH06110	M6 x 110 Ø6	52	F	200	800	AH12110	M12 x 110 Ø12	18	F	50	200
AH06120	M6 x 120 Ø6	62	G	100	600	AH12120	M12 x 120 Ø12	28	G	50	200
AH06130	M6 x 130 Ø6	72	H	100	600	AH12130	M12 x 130 Ø12	38	H	50	200
AH06140	M6 x 140 Ø6	82	I	100	400	AH12140	M12 x 140 Ø12	48	I	50	200
AH06150	M6 x 150 Ø6	92	I	100	400	AH12160	M12 x 160 Ø12	68	J	50	100
AH06160	M6 x 160 Ø6	102	J	100	400	AH12180	M12 x 180 Ø12	88	L	50	150
AH06170	M6 x 170 Ø6	112	K	100	400	AH12200	M12 x 200 Ø12	108	M	50	100
AH06180	M6 x 180 Ø6	122	L	100	300	AH12220	M12 x 220 Ø12	128	O	50	100
AH08060	M8 x 60 Ø8	3	B	100	600	AH12250	M12 x 250 Ø12	158	Q	25	50
AH08075	M8 x 75 Ø8	5	C	100	600	AH14120	M14 x 120 Ø14	12	G	25	100
AH08090	M8 x 90 Ø8	20	E	100	600	AH14145	M14 x 145 Ø14	37	I	25	100
AH08100	M8 x 100 Ø8	30	E	100	400	AH14170	M14 x 170 Ø14	62	K	25	100
AH08115	M8 x 115 Ø8	45	G	100	400	AH14220	M14 x 220 Ø14	112	O	25	75
AH08120	M8 x 120 Ø8	50	G	100	400	AH14250	M14 x 250 Ø14	142	Q	25	50
AH08130	M8 x 130 Ø8	60	H	100	400	AH16125	M16 x 125 Ø16	3	G	25	100
AH08155	M8 x 155 Ø8	85	J	100	200	AH16145	M16 x 145 Ø16	23	I	25	100
AH10070	M10 x 70 Ø10	3	C	100	400	AH16170	M16 x 170 Ø16	48	K	25	50
AH10080	M10 x 80 Ø10	13	D	100	400	AH16220	M16 x 220 Ø16	98	O	25	50
AH10090	M10 x 90 Ø10	10	E	100	400	AH16250	M16 x 250 Ø16	128	Q	25	50
AH10100	M10 x 100 Ø10	20	E	100	400	AH16280	M16 x 280 Ø16	158	S	25	50
AH10120	M10 x 120 Ø10	40	G	50	300	AH20170	M20 x 170 Ø20	23	K	20	40
AH10140	M10 x 140 Ø10	60	I	50	200	AH20220	M20 x 220 Ø20	73	O	20	40
AH10150	M10 x 150 Ø10	70	I	50	200	AH20270	M20 x 270 Ø20	123	S	20	40
AH10160	M10 x 160 Ø10	80	J	50	200						